

nevir

USER MANUAL



NVR-7900-50-4K2-N



IMPORTANTE

Please read this manual carefully before installing and operating the TV.

Keep this manual handy for further reference

Table of Contents

Caution and warning	1
Safety Precautions	2
Preparation for Your New TV	3
Check Accessories	3
Setup TV Table Stand	3
Select TV Location	3
Connection and Using	3
TV Jacks Explanation	5
Side Keypad and Front Panel	6
Side Panel Buttons	6
Front Panel	6
Remote Control Instructions	7
Inserting Batteries in the Remote	7
Remote Control Reception Angle	7
Learning about Remote Control	8
Base Operations	9
Select Input Source	11
Main Menu Operation	12
Picture Menu	12
Sound Menu	14
Channel Menu	15
Time Menu.....	18
System Menu.....	19
About TV Menu.....	22
Media OPERATION	23
Movie Menu	24
Music Menu	25
Photo Menu	26
TV specification	27
Troubleshooting	28
Identifying Problems	28
Wall mount specification	29
Warnings	29

Caution and Warning



CAUTION

**RISK OF ELECTRIC SHOCK
DO NOT OPEN**



Caution: To reduce the risk of electric shock, do not remove cover or back. No user-serviceable parts inside. Refer servicing to qualified service personnel.



The lightning flash with arrowhead symbol, within an equilateral triangle is intended to alert the user to the presence of uninsulated dangerous voltage within the product enclosure that may be of sufficient magnitude to constitute a risk of electric shock.



The exclamation point within an equilateral triangle is intended to alert the user to the presence of important operating and maintenance (servicing) instructions in the literature accompanying the TV.

WARNING: TO REDUCE THE RISK OF FIRE OR ELECTRIC SHOCK, DO NOT EXPOSE THIS APPLIANCE TO RAIN OR MOISTURE.

CAUTION: CHANGES OR MODIFICATIONS NOT EXPRESSLY APPROVED BY THE PARTY RESPONSIBLE FOR COMPLIANCE WITH THE FCC RULES COULD AVOID THE USERS AUTHORITY TO OPERATE THIS EQUIPMENT.

Safety Precautions

1. Read these instructions.
2. Keep these instructions.
3. Notice all warnings.
4. Follow all instructions.
5. Do not use this apparatus near water. For example, do not use near a laundry tub, in a wet basement, or near a swimming pool, and the like.
6. Clean only with dry cloth.
7. Do not block any ventilation openings. Install in accordance with the manufacturer's instructions. Slots and openings in the cabinet back or bottom are provided for ventilation, to ensure reliable operation of the TV and to protect it from overheating. These openings must not be blocked or covered. The openings should never be blocked by placing the TV on a bed, sofa, rug, or other similar surface.
8. Do not install near any heat sources such as radiators, heat registers, stoves, or other apparatus (including amplifiers) that produce heat.
9. Do not modify the safety purpose of the polarized or grounding-type plug. A polarized plug has two blades with one wider than the other. A grounding-type plug has two blades and a third grounding prong. The wide blade or the third prong is provided for your safety. If the provided plug does not fit into your outlet, consult an electrician for replacement of the obsolete outlet.
10. Protect the power cord from being walked on or pinched particularly at plugs, convenience receptacles, and the point where they exit from the apparatus.
11. Only use attachments/accessories specified by the manufacturer.
12. Use only with cart, stand, tripod, bracket, or table specified by the manufacturer, or sold with the apparatus. When a cart is used, use caution when moving the cart/apparatus combination to avoid injury from tip-over. A TV and cart combination should be moved with care. Quick stops, excessive force, and uneven surfaces may cause the TV and cart combination to overturn.
13. Unplug this apparatus during lightning storms or when unused for long periods of time. For added protection for this TV receiver during a lightning storm, or when it is left unused for long periods of time, unplug it from the wall outlet and disconnect antenna or cable system. This will prevent damage to the TV due to lightning and power line surges.
14. Refer all servicing to qualified service personnel. Servicing is required when the apparatus has been damaged in any way, such as power-supply cord or plug is damaged, liquid has been spilled or objects have fallen into the apparatus, the apparatus has been exposed to rain or moisture, does not operate normally, or has been dropped.
15. This TV should be operated only from the type of power supply indicated on the rating label. If customer is not sure the type of power supply in your home, consult your appliance dealer or local power company. For TV remote control battery power, refer to the operating instructions.
16. The TV set shall not be exposed to dripping or splashing. No objects filled with liquids, such as vases, shall be placed on the TV set.
17. Never insert objects of any kind into this TV through openings as they may touch dangerous voltage or other electrical parts that could result in fire or electric shock. Never spill liquid of any kind into the TV.
18. Unplug the TV from the wall outlet before cleaning. Do not use liquid or aero cleaners. Use a damp cloth for cleaning.
19. This TV should never be placed near or over a radiator or heat resource. This TV should not be placed in a built-in installation such as a bookcase or rack unless proper ventilation is provided or the manufacturer's instructions have been adhered to.
20. Do not place this TV on an unstable cart, stand, tripod, bracket, or table. The TV may fall, causing serious injury to someone, and serious damage to the appliance.
21. Do not attempt to service this TV by yourself because opening or removing covers may expose you to dangerous high voltage or other hazards. Refer all servicing to qualified service personnel.
22. **WARNING:** To prevent injury, this apparatus must be securely attached to the floor/wall in accordance with the installation instructions.



Preparation for Your New TV

Check Accessories

Check the accessories that are packed with your TV.

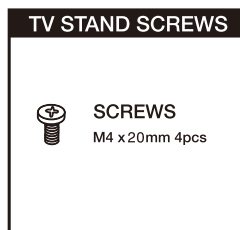
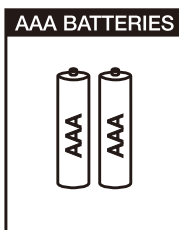
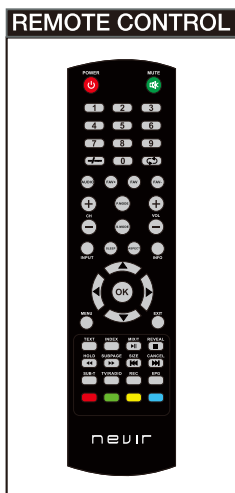

Setup TV Table Stand

Please refer to TV Stand Installation guide on the next page.

Select TV Location

Select a flat, stable table to place your TV set on. Please follow the Safety Instructions when placing the TV.

Connection and Using

After placing your TV properly, you can connect the TV with power supply and cable components. For further information, see page 5 to page 6.

Preparation for Your New TV

The TV is packaged with the TV stand separated from the cabinet. To setup the TV table stand, please carry out the installation according to the instructions below.

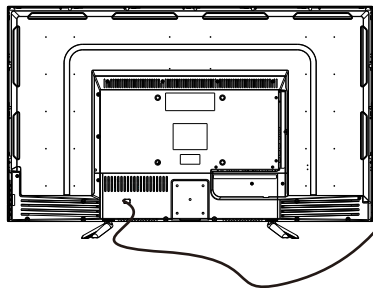

Step One

Place the TV faced down on a soft cloth or cushion to prevent the panel from being damaged

The panel can be scratched easily, so please:

1. Choose an absolutely flat surface to place the TV on.
2. Use soft cloth or cushion to face the TV panel, Do not put TV on the table directly.

Always unplug the AC cord first when installing/removing the stand.

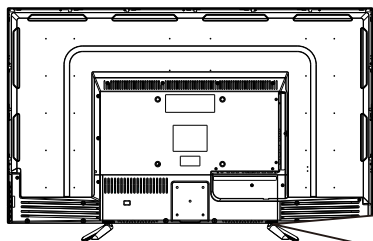

Step Two

Take the base. Please align the screw holes of the base and the TV, and then insert the 4 screws into the 4 holes on the base and tighten them.

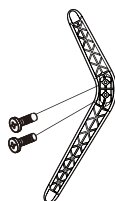

Pedestal Screws	Quantity
M4x20mm	4pcs

Please take note of the base direction:

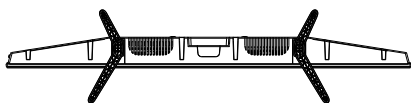

The bottom view of the TV (Front cabinet faces down)

TV Jacks Explanation

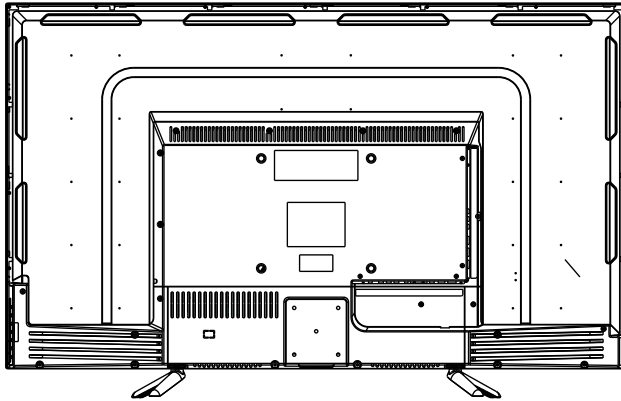

COAX: Digital TV sound output.

HDMI1/2/3: (High-Definition Multimedia Interface) Provides an uncompressed digital connection.

EARPHONE: Connect a 3.5mm headset for personal audio.

SCART: Connect the SCART jack of the DVD or VCR.

RF: Connect to receive the signal from your antenna or cable through a coaxial cable.

MINI AV: Connect the Audio / Video output jack of the DVD or VCR.

MINI YPbPr: Connect the YPbPr output jack of the DVD or VCR.

CI: CI card reader.

USB: Connect the USB device such as the flash disk to access the TV media function.

Side Keypad and Front Panel

Side Keypad Buttons

If you cannot locate your remote, you can use the side keypad buttons on your TV to operate many TV features.

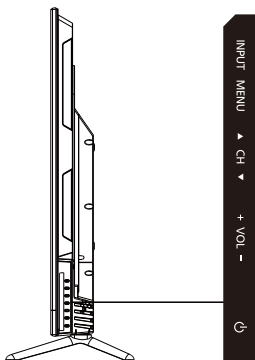

INPUT: Displays the Source Select List.

MENU: Displays the TV Main Menu.

CH▲: Scans up through the channel list. In the TV menu system, it acts like the up arrow on the remote control and can be used to select menu options.

CH▼: Scans down through the channel list. In the TV menu system, it acts like the down arrow on the remote control and can be used to select menu options.

VOL+: Increases the volume. In the TV menu system, it acts like the right arrow on the remote control and can be used to select menu options.

VOL-: Decreases the volume. In the TV menu system, it acts like the left arrow on the remote control and can be used to select menu options.

POWER (⏻): Turns the TV on and off.

Front Panel

About remote control working distance and angle, see next page.

Power/Standby Indicator: Blue and red dual-color LED. It shows red when the TV is turned off and blue when turned on.

Remote Control Sensor: Remote control IR sensor, which receives infrared ray sent by remote control.

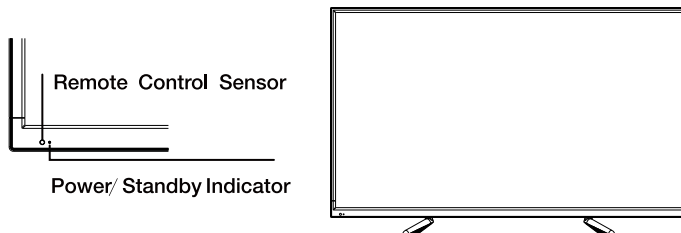

Remote Control Instructions

Inserting Batteries in the Remote

- Remove the cover of battery cabin on the back of the remote control by lifting the cover.
- Insert two AAA batteries, making sure the polarities (+ and -) are aligned correctly.
- Place the cover back.

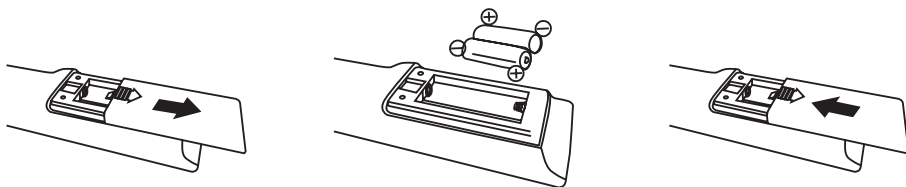

If the remote control does not work, check these points:

- Are the polarities (+, -) correct?
- Are the batteries worn out?
- Is there an AC power failure?
- Is the power cord plugged in?
- Is there any interference or block near the remote control sensor?

CAUTION:

- Used batteries should be recycled.
- Keep out of children's reach.
- DO NOT use new and old batteries together.
- Change both the batteries at the same time.
- When not using the remote control for a long time, remove the batteries from the unit.

Remote Control Reception Angle

Use your remote control within the distance and angle range shown below.

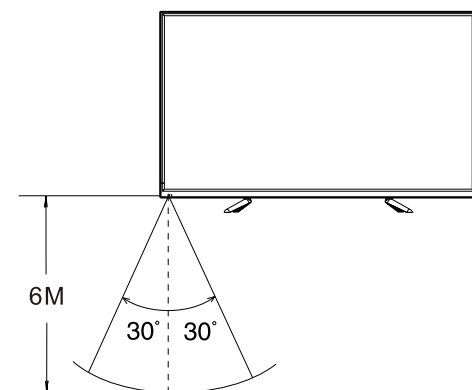

Learning about Remote Control

Remote Control Buttons

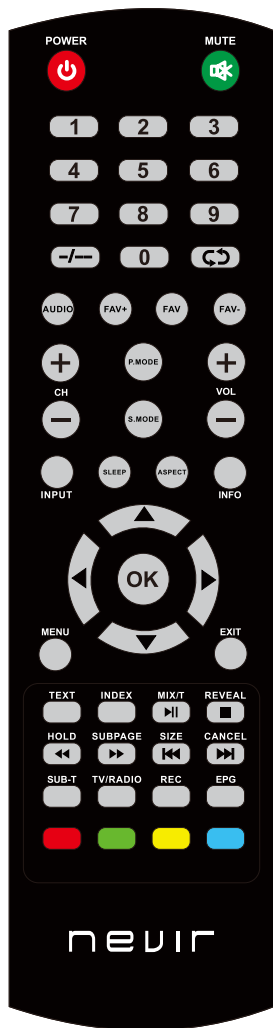

POWER (⏻): Turns the TV on or switches it to Standby.

MUTE (🔇): Reduces the TV volume to its minimum level. Press again to restore the volume.

NUMBER BUTTONS: Press 0-9 select a TV channel directly when you are watching TV.

“**—/—**”: Press once for entering two-digit channels. Press two times for entering three-digit channels.

Recall (📄): Returns to the previous channel.

AUDIO: Switch the audio channel in DVD or multimedia mode.

FAV-./FAV+.: Scan up or down through the current favorite channel list.

FAV: Adds the current channel to your favorite list, or erases the current channel from your favorite list (if this channel is a favorite channel already).

CH+ or CH-: Scans up or down through the current channel list. Press once to change the channel up or down; press and hold to continue changing channels.

VOL+ or VOL-: Increases or decreases the TV volume.

P.MODE: Switches between the preset picture mode.

S.MODE: Switches between the preset sound mode.

INPUT: Accesses the available input channels, Use the arrows to highlight options, and press OK to select.

SLEEP: Selects the sleep timer, after which the TV will shut off automatically.

ASPECT: Switches between the preset screen size mode.

INFO: Press to display the current program information on the screen.

Arrows (⏪/⏩/▲/▼): Uses the four arrows to highlight different items in the TV menu or change the value.

OK: Enter and confirm button.

MENU: Accesses the Main Menu, or return to the upper level of a sub-menu.

EXIT: Exits the current menu or function.

TEXT: To enter Teletext mode. Teletext is not broadcast in New Zealand.

INDEX: To display the index page.

MIX/T: TV and TXT picture are mixed together in transparent background. Press to activate Time Shift function in Digital TV mode, for delayed viewing.

REVEAL: Teletext mode-To reveal or hide the hidden words.

HOLD: Teletext mode-Mode current page which is display.

SUBPAGE: Sub coded page access.

SIZE: Change the size of display in Teletext mode.

CANCEL: To cancel the display.

SUB-T: Display caption information

TV/RADIO: Switch between TV and RADIO. (Used for models with DTV function only)

REC: Personal video record button. A USB memory device must be connected to the USB port for recording.

EPG: Shows Electronic Program Guide.

RED/GREEN/YELLOW/BLUE: Use add-on functions in OSD menu.

▶▶▶▶ Play or pause media files.

■ Stop playing media files.

⏪⏩ Fast review and fast forward.

⏮⏭ Select the previous or the next media file.

Basic Operations

First Time Settings.

Please according to the Text Tip to First Time Installation.

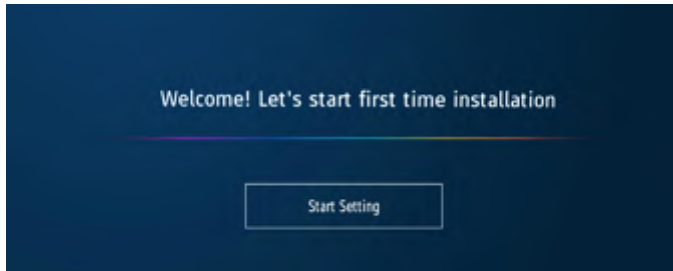

Language

Select the language to be used for menus and message.

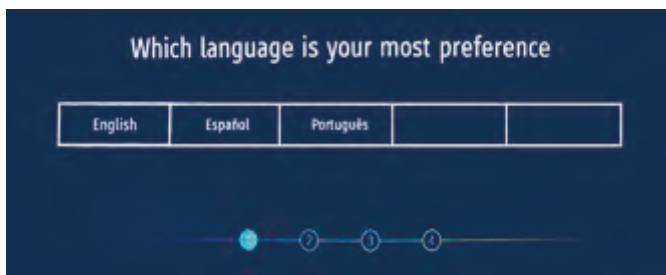

Country

Press ◀/▶ button to select the country for you want to.

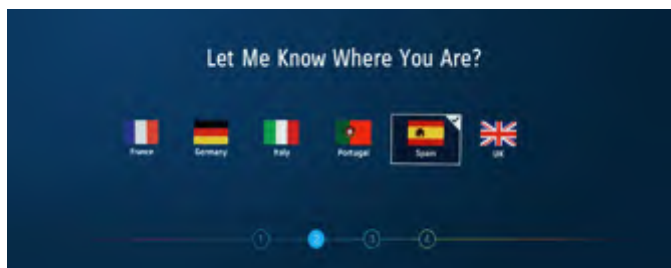

Basic Operations

Environment

Choose the environment mode.

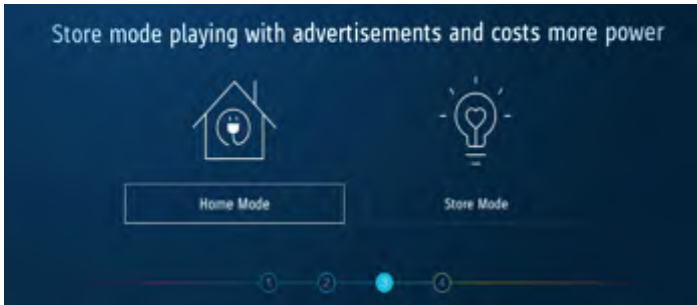

Choose the input source

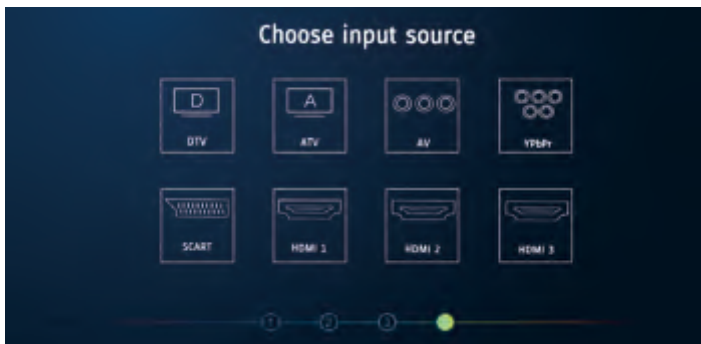

Select Input Source

Press **INPUT** button to display the input source list.

Press ◀/▶ buttons to select the input source you want watch.

Press **OK** button to enter the input source.



Adjust the OSD Screen

The OSD (On Screen Display) menu enables you to approach to the TV functions.

To use OSD menu system, press MENU button on remote control, then use ◀/▶ arrow to highlight an option from QUICK SETTINGS, PICTURE, SOUND, CHANNEL, TIME, SYSTEM, ABOUT TV and press OK button.

Press the ◀/▶ arrow to move to a different option within each menu. If necessary, press OK button to display the choices of the option you've highlighted. If available, use the text at the bottom of each screen for help. To return to the previous menu, press the MENU button.

To exit the OSD menu:

- Press the EXIT button. The menu will clear from the screen.
- Press the MENU button repeatedly until the menus disappear.

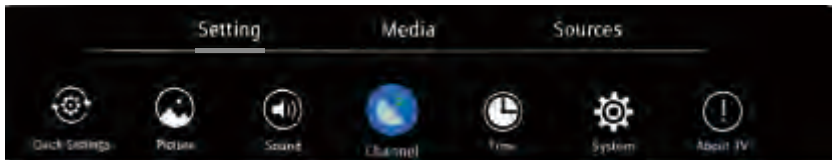

Quick Settings

Press [◀] / [▶] button to select the **Quick Settings**.

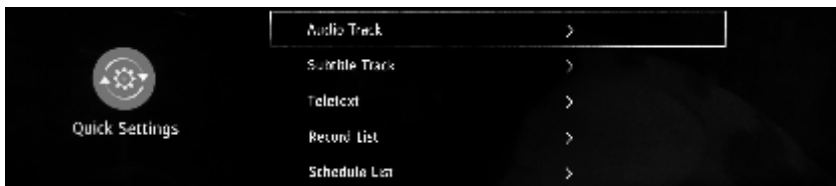

- | | |
|-----------------------|--|
| Audio Track | Select the program audio language. |
| Subtitle Track | Select the program subtitle language. |
| Teletext | On/Off the teletext. |
| Record List | View the program list you set to record. |
| Schedule List | View the program list you set to watch. |

Main Menu Operation

Picture Menu

Press **【▼】 / 【▲】** button to select the option that you want to adjust in the **Picture** menu, then press **Enter** button to adjust.

After finishing your adjustment, Press **Enter** button to save and return to the previous menu.



Picture Mode

Press **【▼】 / 【▲】** button to select **Picture Mode**, then press **【◀】 / 【▶】** button to select.

Note: Press **PMODE** to select Picture Mode quickly.

- | | |
|-----------------|--|
| ECO | Reduce screen brightness, improved contrast for energy saving. |
| Standard | The default mode, to make users experience high-quality images under normal light. |
| User | User-defined picture settings |
| Mild | Image colors more gentle to protect eyes. |
| Dynamic | This mode is more suitable for watching dynamic program. |
| Vivid | This mode enhance contrast and sharpness to make picture more vivid. |

NOTE: The following functions are available , When select the User in picture mode.

Brightness/Contrast/Colour/Tint/Sharpness/Backlight

Press **【▼】 / 【▲】** to select, and press **【◀】 / 【▶】** to adjust.

- | | |
|-------------------|---|
| Brightness | Adjust the light output of entire picture, it will effect the dark region of the picture. |
| Contrast | Adjust the highlight intensity of picture, but the shadow of the picture is invariable. |
| Colour | Adjust the saturation of the color based on your own like. |
| Tint | Adjust image color density. |
| Sharpness | Adjust the image edge sharpness. |
| Backlight | Adjust image brightness. |

Main Menu Operation

Aspect Ratio

Press **【▼】 / 【▲】** to select **Aspect Ratio**, press **【◀】 / 【▶】** to select.
(Optional:Auto,16:9,4:3,Zoom1,Zoom2).

Advanced Settings

Enter to **Advanced Settings**, press **【▼】 / 【▲】** button to select the menu you want.

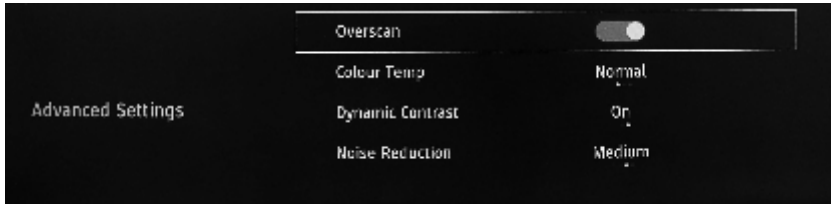

Colour Temp

Adjust the overall color of the image.Press **【▼】 / 【▲】** to select Colour Temp.
press **【◀】 / 【▶】** to select.

- Cool** Produces a gentle blue-hued image.
- Standard** Produces a vivid image.
- Warm** Produces a red-hued image.

Dynamic Contrast

Adjust image contrast.Press **【▼】 / 【▲】** to select,and press **【◀】 / 【▶】** to adjust.
(Optional:On/Off).

Noise Reduction

Adjust image noise.Press **【▼】 / 【▲】** to select,and press **【◀】 / 【▶】** to adjust.
(Optional:Off/Low/Medium/High).

Main Menu Operation

Sound Menu

Press **【▼】 / 【▲】** button to select the option that you want to adjust in the **Sound** menu, then press **Enter** button to adjust.

After finishing your adjustment, Press **Enter** button to save and return to the previous menu.

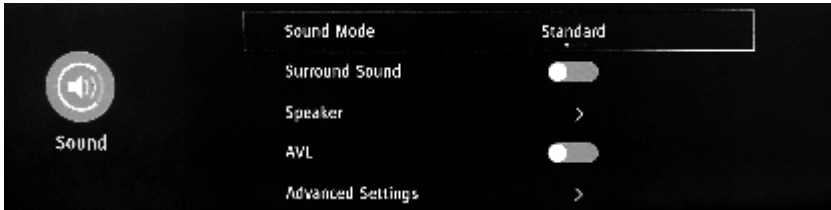

Sound Mode

Press **【▼】 / 【▲】** button to select **Sound Mode**, then press **【◀】 / 【▶】** button to select.

Standard Produce a balanced sound in all environments.

Music Preserve the original sound. Good for musical programs.

Theater Enhance treble and bass for a rich sound experience.

User Select to customize sound settings.

Note: Press **SMODE** to select Sound Mode quickly.

Surround Sound

Press **【▼】 / 【▲】** button to select **Surround Sound**, then press **【◀】 / 【▶】** button to choose ON/OFF.

Speaker

Press **【▼】 / 【▲】** button to select **Speaker**, then press **【▼】 / 【▲】 / 【◀】 / 【▶】** button to adjust.

AVL

This item is used for reducing the difference between program's volume automatically.

Press **【▼】 / 【▲】** button to select **AVL**, then press **【◀】 / 【▶】** button to choose ON/OFF.

Advanced Settings

Press **【▼】 / 【▲】** button to **Advanced Settings**, then press **【▼】 / 【▲】 / 【◀】 / 【▶】** button to adjust.

Balance

Adjust the left and right channel output balance.

Press **【▼】 / 【▲】** button to select **Balance**, then press **【◀】 / 【▶】** button to adjust.

Audio Description

Select ON/OFF.

Main Menu Operation

Channel Menu

Press **▼** / **▲** button to select the option that you want to adjust in the **Channel** menu, then press **Enter** button to adjust.

After finishing your adjustment, Press **Enter** button to save and return to the previous menu.



Auto Scan

Press **▼** / **▲** button to select **Auto Scan**, then press **Enter/▶** button to enter.



Select the DTV/DTV+ATV/ATV, and press **ENTER** to search the programs. First searching the DTV, press **MENU** to stop and searching the ATV.

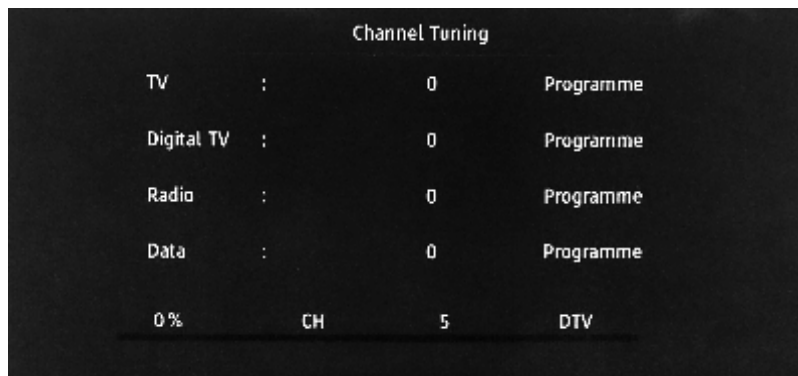

Main Menu Operation

Manual

Press ▼ / ▲ button to select **Manual**, then press **Enter/▶** button to enter.

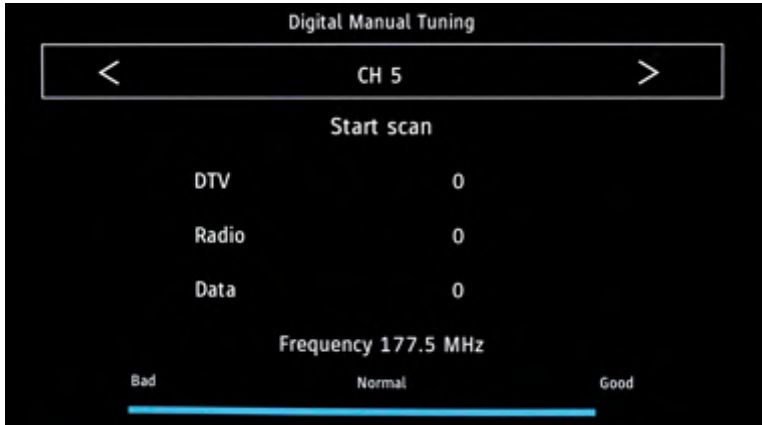

Select the ATV in Source. Press ▼ / ▲ button to select **Auto Scan**, then press **Enter/▶** button to enter.

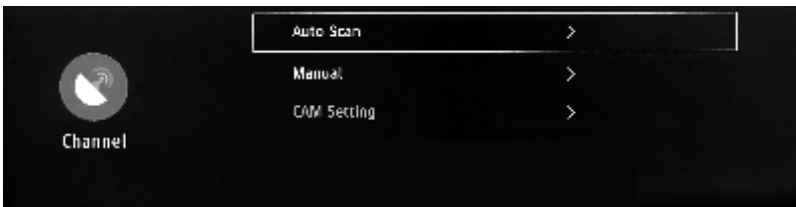

Main Menu Operation

Manual

Press ▼ / ▲ button to select **Manual**, then press **Enter/▶** button to enter.

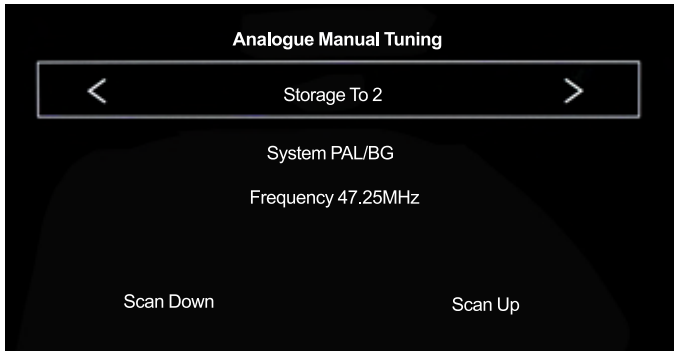

Signal Information

Press ▼ / ▲ button to select **Signal Information**, press the **Enter** button to view the detail information about the signal. Only available when there is signal in DTV.

CAM Setting

Input the password so that you can watch the program encrypted.

Channel List

Press **ENTER** button to select **Channel List**, then press **ENTER** button to enter sub-menu.



Main Menu Operation

Time Menu

Press **【▼】 / 【▲】** button to select the option that you want to adjust in the **Time** menu, then press **Enter** button to adjust.

After finishing your adjustment, Press **Enter** button to save and return to the previous menu.

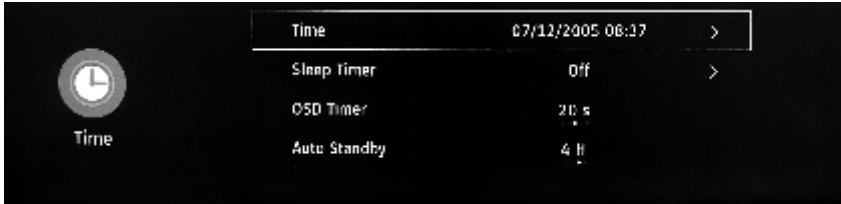

Time

Press **【▼】 / 【▲】** button to select **Time**, and press OK button to set the TV time.

Sleep Timer

Press **【▼】 / 【▲】** button to select **Sleep Timer**.

(Optional: off, 10min, 20min, 30min, 60min, 90min, 120min, 240min).

OSD Timer

Press **【▼】 / 【▲】** button to select **OSD Timer**, Press **【◀】 / 【▶】** to select.

(Optional: Never, 10S, 20s, 30s, 60s).

Auto Standby

Press **【▼】 / 【▲】** button to select **Auto Standby**, Press **【◀】 / 【▶】** to select.

(Optional: Off, 3H, 4H, 5H).

Main Menu Operation

System Menu

Press **【▼】 / 【▲】** button to select the option that you want to adjust in the **System** menu, then press **Enter** button to adjust.

After finishing your adjustment, Press **Enter** button to save and return to the previous menu.



Country

Press **【▼】 / 【▲】** button to select **Country**, Press **【◀】 / 【▶】** to select you want.

Language

Press **▼ / ▲** button to select Language. Press **◀ / ▶** to select the display language. MENU Language, press **▼ / ▲** button to select OSD language.

Audio Language

Press **▼ / ▲** button to select Primary Audio Language/Secondary Audio Language, press **◀ / ▶** to select the Audio language.

Subtitle Language

Press **▼ / ▲** button to select Primary Subtitle Language/Secondary Subtitle Language, press **◀ / ▶** to select the Subtitle language.

Main Menu Operation

Lock

Press ▼ / ▲ button to select Lock, and press ◀ / ▶ to set (The default password:0000).



Set Password

Press [▼] / [▲] button to select **Set Password**.

Channel Lock

Press [▼] / [▲] button to select **Channel Lock**, and press green button to lock/unlock the channel.

Parental Guidance

Some program may not be suitable for children. Parents can shield unsuitable show automatically, by setting Parental Guidance .,

Press ▼ / ▲ button to select Parental Guidance.

Press ▼ / ▲ button to select Off, 4, 5, 6, 7 . . 18.(Age of children)

Key Lock

Select to lock/unlock the key board.

Hotel Mode

Press ▼ / ▲ button to select hotel mode, and press ◀ / ▶ to set to you want.



Hotel mode: Press ▼ / ▲ button to select the Hotel mode item, and then use ◀ / ▶ button to select the on/off hotel mode.(Note Only turn hotel mode you can adjust source lock, default source, default prog, max volume.)

Source Lock: Press ▼ / ▲ button to select the Source Lock item, and then use ◀ / ▶ button to enter sub menu to select source want to lock.

Default Source: Press ▼ / ▲ button to select the default source item, and then use ◀ / ▶ button to select default source.

Main Menu Operation

DTV Channel Type: Press ▼ / ▲ button to select the DTV Channel Type item, and then use ◀ / ▶ button to select for you want.

Default Programme: Press ▼ / ▲ button to select the Default Programme item, and then use ◀ / ▶ button to select the Default Programme. (Note only available when default source is DTV.)

Default Volume: Press ▼ / ▲ button to select the Default Volume item, and then use ◀ / ▶ button to set the Default Volume.

Max Volume: Press ▼ / ▲ button to select the Max Volume item, and then use ◀ / ▶ button to set the Volume.

CH Table Import: Press ▼ / ▲ button to select the CH Table Import item, and press enter button to start import the Table from the USB Flash disk. Make sure the U disk you have inserted has the data you want to import to your TV system.

CH Table Export: Press ▼ / ▲ button to select the CH Table Import item, and press enter button to start export the Table to the USB Flash disk. Note: You must insert the USB flash disk before you do the export setting and import setting.

Clear Lock: Press ▼ / ▲ button to select the clear lock item, and use the ◀ / ▶ button to clear the hotel setting.

USB clone to TV: Press ▼ / ▲ button to select USB clone to TV item, and press enter button to Start copying the TV settings from the USB device into the TV

TV clone to USB: Press ▼ / ▲ button to select USB clone to TV item, and press enter button to start Start copying the TV settings into the USB device.

HDMI Settings

Press ▼ / ▲ button to select the HDMI setting item, and then use ◀ / ▶ button to select for you want.

Advanced Settings

Hearing Impaired

Show the description of the program.

Setup Wizard

Enter the first time installation to set the settings.

Blue Screen

ON/OFF the blue screen.

Media Operation

PVR

Press the REC button on the remote control to enter the PVR burning menu



Press Play button to play the record file right now.



Stop and finish recording, and quit PVR .



Pause recording.



Press to play fast backward.



Press to play fast forward.

About TV Menu

Press **【▼】 / 【▲】** button to select the option that you want to adjust in the **About TV** menu, then press **Enter** button to adjust.

After finishing your adjustment, Press **Enter** button to save and return to the previous menu.

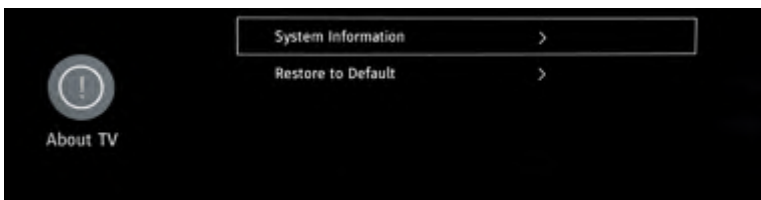

System Information

Press **【▼】 / 【▲】** button to select **System Information**, then press **ENTER** button to enter.

Restore to Default

Press **【▼】 / 【▲】** button to select **Restore to Default** to the default settings.

Media Operation

Multimedia

MEDIA OPERATION

The picture is for a reference only; the actual item is the standard.

Note: Before operation **MEDIA** menu, Plug in USB device or memory card, then press [◀] / [▶] button to select **MEDIA** menu.

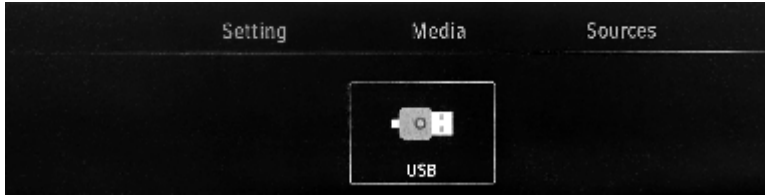

1. Press ▲/▼ button to select the option that you want to adjust in the **Media** menu, then press **ENTER** or ► button to enter.
2. Press ◀/▶ button to adjust or press ▲/▼ button to select.
3. After finishing your adjustment, press **MENU** button to save and return back to the previous menu and press **EXIT** button to exit the entire menu.

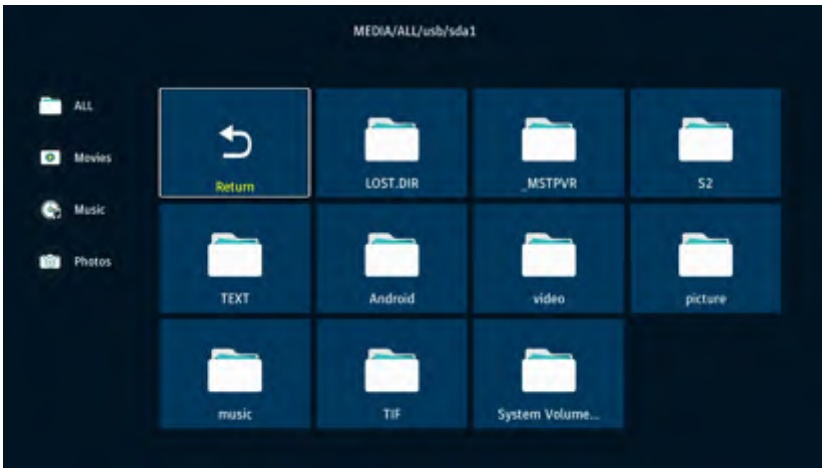

Media Operation

Movies

Press [▼] / [▲] button to select Movie.



Press to play the previous movie.



Press to play back faster.



Press to pause the movie.



Press to play forward faster.



Press to play the next movie.



Press to set the picture scale.



Press to repeat the movie.



View the list to play.



View the information of the movie.

Media Operation

Music

Press [▼] / [▲] button to select Music.



Press to repeat the music.



Press to play back faster.



Press to pause the music.



Press to play forward faster.



Press to select the encoding of lyric.

Media Operation

Photos

Press [▼] / [▲] button to select Photos.



Press to play the previous photo.



Rotate 90° anticlockwise.



Press to pause playing next photo.



Rotate 90° clockwise.



Press to play the next photo.



Press to repeat the photos in the current folder.



View the list to play.



View the information of the photo.

SPECIFICATIONS

Product Specifications

Model:	NVR-7900-50-4K2-N
Video:	avi, MPEG
Music:	mp3, AAC
Photo:	jpg , jpeg, bmp, png
Screen resolution:	3840x2160
Working voltage:	100-240V~50/60Hz
Rated power consumption:	115W
Dimensions:	1129x 717 x 260mm

Troubleshooting

Identifying Problems

If there are any problems when using the product, please consult the list below. If the list does not solve the problem, call our Customer Service Center immediately.

TV Problems

The TV can't be turned on.

- Make sure the AC cord is plugged in.
- Check the wall outlet, make sure the AC output works normally and stably.
- Select the Key Lock function in the OPTION Menu and press OK to uncheck the locking status.

No picture or sound but the TV is on and there is a "No Signal" sign on screen.

- Are you trying to use an input source with no device connected to it? For using other video/audio device, make sure the external device works normally first, then press Source and choose the right input source.
- The signal type option may be set incorrectly.
- The channel may be blank. Try to search the channel again or change another channel.

The sound is fine, but the picture is poor.

- If you can only get black and white pictures from external device that you've connected to your TV, maybe it is due to the video cables is not connected well, or they are connected wrongly. Check the connection stability first, then check the correctness.
- For AV input, the yellow video cable connects to the yellow Video In jack on the side of your TV. For Component input, the three Y, Pb, Pr video cables (red, blue, and green) should be connect to the corresponding input jacks on the side of your TV.
- Check the antenna connections. Make sure all of the cables are firmly connected to the TV jack on side of your TV.
- Try adjusting the color features to improve.

There is no sound, but the picture is fine.

- The sound might be muted. Try pressing the MUTE button to restore sound.
- For using AV or Component, remember to connect the device's left and right audio output correctly. The left channel cable is white and the right channel cable is red. Please match the cables and jacks according to their colors.
- The sound settings may not be set correctly.
- If your audio source has only one jack or is a (mono) audio source, make sure you have plugged the connection into the Audio In L jack (white) on the TV.

The buttons on the side panel don't work.

- Unplug the TV from the AC power for 10 minutes and then plug it back. Turn the TV on and try again.

The TV turns off unexpectedly.

- The electronic protection circuit may have been activated because of a power surge. Wait 30 seconds and then turn the TV on again. If this happens frequently, the voltage in your house may be abnormal. If the other electronic equipment in your home can't work normally, consult a qualified service personnel.

The Remote control doesn't work.

- Something might be blocking between the remote control and the remote sensor on the front panel of the TV. Make sure there is a clear path.
- The remote may not be aimed directly at the TV.
- The batteries in the remote may be weak, dead, or installed incorrectly. Put new batteries in the remote.

Wall Mounting (if available)

Unit Dimension (unit:mm)	Screws
VESA 200x200	M6 screws, length 10mm, 4 pcs

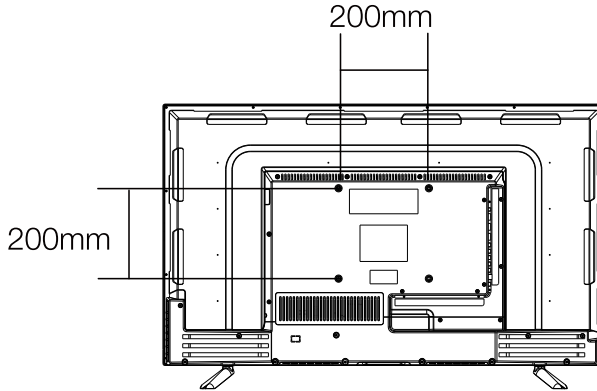

Note:

A. The wall mount is not contained in the accessories sold with television. We only provide the installing specifications but not the wall mount itself. If you need the mount, please consult with the local dealer for a VESA wall mount.

B. We strongly suggest to set the wall mount with equipments of specification we ordered. If not, inappropriate installing may cause damage to device or people.

Warnings:

1. Do not set up the wall mount by yourself. Please contact qualified professionals for installation.
2. The TV should not be mounted on walls or surfaces which have an angle more than 10 degrees with vertical direction. Otherwise the TV set may fall.
3. The walls for mounting must have enough strength to hold the whole weight of TV set. For example, concrete wall and brickwork are eligible. Do not place the mount on soft walls such as earth walls and plasterboard.
4. If spare parts of different specifications (such as screws) are used during mounting, consult with qualified professionals to make sure these parts are safe and effective.
5. Before attaching the base to wall, ensure the holes for anchors are in keeping with the installing rules. Otherwise there may exist some potential problems.
6. Do not place any heating source under your television. Or else, it can cause fire.
7. Do not place the TV near anything dripping. Transducers and high voltage wires should be kept far away from the apparatus too. Or else, it may cause creepage, electric shock or bad resonance.
8. Do not place TV in a location where collision or vibration is liable to happen.
9. In order to avoid unexpected falling of the TV set, do not put any strong force on TV or wall mount after installing.
10. Be sure to unplug the TV before installing. Keep anything hard or sharp away from the screen panel to prevent the scuffing.
11. After installing, if there is any need to move the cabinet, please contact the qualified professionals.

The European Directive 2002/96 /EC on Waste Electrical and Electronic Equipment (WEEE) required that old household electrical appliances must not be disposed of in the normal unsorted municipal waste stream. Old appliances must be collected separately in order to optimize the recovery and recycling of the material they contain, and reduce the impact on human health and the environment. The crossed out "wheeled bin" symbol on the product remind you of your obligations that when you dispose of the appliance, it must be separately collected.

Besides that, waste batteries and/or accumulator must be removed prior to delivery of WEEE, through the separated collection channels provided for this purpose (distributors and/or facilities from Local Authorities) In order to fulfill ruling UNE EN-60335, we indicate that if the flexible wire is damaged, it can only be replaced or repaired by a technical service recognized by NEVIR S.A. as per special tooling is required.



DECLARACIÓN DE CONFORMIDAD

NEVIR, S.A. declara bajo su responsabilidad que el aparato indicado cumple los requisitos de las siguientes directivas:

DIRECTIVA EMC

EN 55032:2015
EN 55020:2007+A11:2011
EN 55024:2010+A1:2015
EN61000-3-2:2014
EN61000-3-3:2013

LOW VOLTAGE DIRECTIVA EEC

Product: TELEVISOR DLED 50" UHD (127cm) con TDT HD

Trade Mark:

Model: D50RWB624-U-T2C, NVR-7900-50-4K2-N
XXXXXXXX40XXXXXXXXXXXXXX, (Where "X" can be any alphanumeric of a-z, A-Z or 0-9 or blank or-)

And, in accordance with the following applicable directives:
2014/35/EU Low Voltage Directive.

That this product has been assessed against the following applicable standards;EN 60065:2014 Audio, video and similar electronic apparatus – Safety requirements.

Descripciones del aparato: TELEVISOR DLED 50" UHD (127cm) con TDT HD
TDT HD

Modelo NEVIR: **NVR-7900-50-4K2-N**

Importador: **NEVIR, S.A.**

Dirección del importador: NEVIR, S.A.
C/ Canteros, 14
Parque Empresarial Puerta de Madrid
28830 San Fernando de Henares, Madrid



